

9th International Conference on Axiomatic Design – ICAD 2015

Addressing the adaptive customization of timber prefabricated housing through Axiomatic Design

Marianna Marchesi^{a,*} and Ian Alessandro Ferrarato^b

^aFree University of Bozen-Bolzano, Piazza Università, 5 39100 Bolzano, Italy

^bVia S. Eufemia, 30 35121 Padova, Italy

* Corresponding author. Tel.: +39-349-181-2179. E-mail address: marianna.marchesi@natec.unibz.it

Abstract

The current Italian housing market requires customized high-performance buildings at an affordable cost. Timber building prefabrication represents a suitable way to satisfy this demand, but its application for this purpose is at the moment inadequate mainly due to restrictions of production approaches: the lack of variety of low-cost mass-produced buildings and the high costs of ad-hoc full-customized buildings. In order to provide affordable customized houses, the timber building industry should focus on designs characterized by the combination of mass-produced and customized parts. In this way, clients would have the chance to personalize decisive parts for them, and the building industry can limit costs by the mass production of the others. This strategy involves artefact flexibility and robustness with regard to the architect's viewpoint. Crucial decisions for the achievement of these requirements are made in the conceptual design phase, but in this stage architects' decision making is not supported by suitable approaches. Axiomatic Design (AD) has been shown to be able to support decision making for the development of concepts that would have the best chance to provide the specified requirements. In this study AD is applied to prefabricated building design in the timber housing industry. Despite limitations placed by timber construction systems, this application results in a prefabricated building system enhanced with regard to robustness and flexibility, and therefore better able to foster designs that satisfy the current housing demand.

© 2015 The Authors. Published by Elsevier B.V. This is an open access article under the CC BY-NC-ND license (<http://creativecommons.org/licenses/by-nc-nd/4.0/>).

Peer-review under responsibility of the organizing committee of 9th International Conference on Axiomatic Design

Keywords: Axiomatic Design; decision making; robustness; flexibility; building design; adaptive customization; timber building industry

1. Introduction

In Italy, the current housing demand requires customized high-performance buildings at affordable costs [1]. Timber building prefabrication is a suitable way to satisfy this demand. Thanks to the high-customization and high-performance that timber building prefabrication is able to guarantee, the market of timber prefabricated buildings is increasing in spite of the crisis of the building sector [2]. However this wide deployment has been actually limited mainly due to restrictions of production approaches: the high cost of ad-hoc full-customized prefabricated buildings, and the lack of customer appreciation of low-cost mass-produced prefabricated buildings. In order to satisfy the current housing demand, the timber building industry should focus on achieving customer appreciation and, at the same time, limiting building costs. This aim is achievable through a compromise between customization and mass production. It

consists of the development of designs composed of customized and mass-produced parts [3]. In this manner, customers are able to personalize building parts that are crucial for them, and the building industry can limit building costs by mass-producing the others. This approach provides artefact flexibility and robustness from the architect's viewpoint. Crucial decisions on the achievement of these requirements are made in the conceptual design phase, but in this stage architects' decision making is not supported by adequate approaches [3]. AD is a design theory that proposes a rational structure, a systematic procedure and principles of synthesis and decision making for the development and evaluation of designs with regard to artefact robustness [4] and flexibility [5] from the designer's and user's viewpoints. Past studies have shown the compatibility of AD to the architects' design approach and benefits of applying AD to building and civil engineering design [6]. Since artefact robustness and flexibility are, from the architect's viewpoint,

crucial requirements for prefabricated building designs to satisfy the current housing demand, and because AD has been shown to help achieve this [4], AD is applied to building design in the housing industry.

Applying AD shows that the main timber construction systems commonly applied by the Italian timber building industry limit artefact robustness and flexibility. In spite of these limitations, AD guides the early decision making toward the design development of a timber building system enhanced with respect to the specified requirements. Therefore it is better able to foster building solutions that satisfy the current housing demand.

2. Background

2.1. Timber building prefabrication

Building prefabrication consists of building linear elements (frames), planar elements (panels) or spatial elements (room modules) that are pre-made in factories, and then transferred, assembled and installed permanently on the building site [7].

In spite of the building sector crisis, the market of timber prefabricated buildings in Italy is constantly growing [2] due to high performances at competitive prices compared to other construction systems and the short construction time that prefabricated timber construction systems are able to guarantee. In particular, the housing market requires customized buildings at affordable costs without prejudicing adequate performances in order to satisfy a varied and segmented demand [1]. Timber building prefabrication represents a suitable way to satisfy this demand, but actually its application for this purpose is inadequate mainly due to restrictions of two opposite production approaches: the low customer appreciation of low-cost mass-produced buildings on one hand and the high cost of ad-hoc full-customized buildings on the other hand. The adoption of the mass production strategy permits consistent economies, but the artefact is highly standardized and the customer appreciation is low due to the strongly limited chance of customization. As an alternative to low-cost high mass-produced solutions, the building industry proposes ad-hoc full-customized solutions. In this approach, building components are one-off and designed according to the specific client's needs, but building costs are high. In order to provide customized houses at affordable costs, Italian timber building industry needs to update its approach to design and production. This study asserts that mass customization, especially adaptive customization, is a suitable approach to satisfy the current housing demand. Adaptive customization is a mix between mass production and customization by the combination of mass-produced and customized artefact parts [3]. It allows clients to personalize parts that are crucial for them and limits costs by mass-producing the others.

In adaptive customization, artefact robustness and flexibility are both crucial requirements from the designer's point of view. The first requirement expresses the ability of an artefact to produce the expected performances despite being subjected to uncertainties and disturbances (e.g. changing customers or functions or physical components) [4]. The

second requirement expresses the ability of an artefact to be adapted in terms of functionality or performance features in order to yield similar design families with little effort, time, or penalty in response to market demand [5]. These abilities depend greatly on decisions made by architects in the early phase [8].

In the Italian timber building industry, the platform frame and the loading panel are the two main timber construction systems commonly used [2]. The platform frame system consists of pre-assembled frames of linear timber members that are braced by flat cladding panels or diagonal boards. The inner sheathing carries loads and provides rigidity, while the outer sheathing closes the frame in which the thermal insulation is embedded. It is covered with service system cavity internally and with finishing on both sides. The assembly on site involves erecting and jointing wall panels. Construction is based on the principle of stacking stories one upon the other. The platform frame construction has a high degree of prefabrication due to the use of identical common timber sections with small size and standard building boards [9]. The loading panels system is a box-shaped construction similar to masonry construction. It is made by rigid panels manufactured by crossed timber layers and cut in factory. Then they are assembled, connected and covered on site with insulation externally and service system cavity internally. The walls are usually one-floor high, and each floor constitutes the platform for the following story [9].

2.2. Conceptual building design

The conceptual phase is the most challenging stage of the building design process: crucial decisions with fundamental effects on the design outcomes are made in this phase when the opportunity to influence them is highest. Instead poor decisions made initially cannot be corrected in later stages [10]. In spite of the decisive role of the initial design phase, design process in architecture does not start with a full and explicit definition of the problem. Usually architects begin selecting a small set of design objectives depending on their subjective judgment, experience and knowledge in order to limit potential solutions to a manageable group. Then accordingly they elaborate and propose a design conjecture to client in order to obtain more information about the design problem. As a result, during the process, problem and solution are constantly reformulated; they co-evolve together until they are both completely defined [11]. In the early phase only few design tools are available to sustain this phase while most of them support detailed phases. Architects emphasize intuition and experience, but this approach may not be actually adequate due to the current design complexity [12]. Especially early architect' decision making needs supports to address solutions toward the achievement of the expected outcomes. In engineering, suitable design procedures are available.

3. Axiomatic Design

AD is a design theory developed by Nam P. Suh in engineering field and applied to many different types of problem solving in form of products, processes or systems.

AD guides the early designer's decision making from synthesis to analysis of ideas and selection of the best idea among plausible solutions [7, 8] with respect to artefact flexibility [5] and robustness [4] from the designer's and user's viewpoints. In AD, designers initially define what they want to achieve functionally, and then establish how to achieve it physically. They define the expected functions in terms of functional requirements (FRs). Artefact functions are what an artefact should perform to satisfy customer needs [5], and concern the exchange of signals, information, materials, forces, and energy [5]. In addition there are desirable qualities or attributes that the artifact should have to be accepted. They imply the definition of restrictions and constraints on the product or on how the product must be designed, and affect the mapping process from FRs to physical components (called design parameters - DPs) [13]. FRs are mapped into DPs that implement physically the defined functions. The mapping between FRs and DPs is usually one-to-one, many-to-one, or one-to-many. In one-to-one mapping, each DP implements one FR while in many-to-one a DP implements many FRs [5]. In AD, the definition of FRs and the mapping between FRs and DPs are both dependent on the axiom one. The axiom one or independence axiom states that the independence of the FRs as well as the one-to-one mapping between FRs and DPs must be maintained to minimize coupling between FR/FR and FR/DP pairs and avoid conflicts [14, 15]. Such decoupling warrants that a variation of one DP or one FR will not destabilize the whole solution. In this way, it is fostered the artefact robustness from the designer's viewpoint [4]. Couplings are identified by the check of the design matrix (DM); so they can be reduced or eliminated. The second axiom or information axiom supports the selection of the best design among alternatives by the evaluation of the artefact robustness from the user's point of view [4]. This axiom states that a decoupled design should also follow the principle of minimum information for the user (consumer or manufacturer). This means that the user should not have to adjust any design parameter in order to benefit from the functions of the system [4]. Axiom two will not be applied in this study. Finally the defined DPs are physically integrated into one entity, and interacting components are connected by interfaces. In AD, every DP should be combined without introducing unwanted couplings between FRs and DPs and between DPs [14, 15]. This scheme fosters the artefact flexibility from the architect's and user's points of view. This attribute expresses artefact ability to be changed during the design phase or over its life cycle and successive generations [5]. When each DP implements one FR and the interactions between DPs are decoupled, the design scheme is called modular architecture. In summary it results in being robust from the architect's viewpoint [4] and flexible from the architect's and user's points of view [5].

Past studies have highlighted the compatibility of AD to the architects' design approach [6] because of its interplay between problem and solution. AD has resulted in being a suitable approach for supporting the early architects' decision making. Recent applications of AD to building and civil engineering design have shown benefits of applying AD in the conceptual design of the built environment in complex built

artefacts with large flow of people such as airport [16] or with large flow of vehicles such as infrastructures and roads intersections [17, 18]. Moreover AD has been applied to the early decision making in the concept design development of temporary and sustainable housing [19, 20].

The artefact abilities of being robust and flexible, both with respect to the designer's viewpoint, appear crucial requirements for a prefabricated building system that satisfy the current housing demand. AD has shown to be able to address design toward the achievement of these requirements. Therefore this study proposes the application of AD to building design in the timber building industry in order to develop a suitable prefabricated system.

4. Applying Axiomatic Design to the design of a timber prefabricated building system

Design intents are expressed in terms of functional requirement (FR) and corresponding design parameter (DP).

FR0 = provide affordable customized high-performance timber houses

DP0 = timber prefabricated modular-architecture housing system

The architectural form initially defined is usually developed by architects and critics as the evolving interplay of three converging factors: "topos", "typos" and "tectonic" [21]. "Topos" refers to context, site and orientation; "typos" concerns user activities and spaces relationship; finally "tectonic" pertains to construction for the generation of suitable spaces. Site provides design inputs and constraints (Cs) to the evolution of the architectural form setting restrictions on the solution or on how the solution must be designed to be acceptable. Construction is generally distinguished between skeleton construction, massive construction and hybrid construction [9]. Skeleton construction is made from linear members, and thanks to this nature, it is able to support client's activities without conditioning the creation of interior space and without separating interior from exterior. On the contrary, massive construction is made from walls that perform the loadbearing and enclosing functions together. They create interior spaces directly. Therefore interior and exterior are distinctly separated. Hybrid construction is a combination between skeleton construction and massive construction [9]. The two timber construction systems commonly applied by the timber building industry are classified accordingly. The loading panel system results in being a massive construction because timber walls perform both loadbearing and enclosing functions, and create interior spaces directly. Instead the platform frame system results in being a hybrid construction. Similarly to massive constructions, this construction system encloses directly interior space separating interior from exterior because the loading and separating functions are united in the same plane. At the same time, similarly to skeleton constructions, each individual layer performs essentially just one function thanks to its linear members providing design freedom concerning plan layout and openings positioning. According to the notion of architectural

form previously explained, the initial minimum set of independent FRs is defined as follow:

- FR1 = accommodate clients' living pleasantly
- FR2 = support client's living safely and comfortably

The proposal is located in a hypothetical site, but it should be able to be adapted to different location, contexts and climate features. An initial architectural form is defined (Figure 1) that satisfies the specified FRs, and observes existing constraints (Cs).

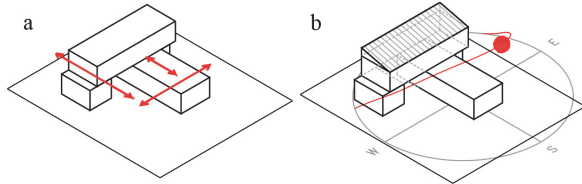

Fig. 1. Initial design concept: (a) inside-outside relationship; (b) orientation.

This early design consists of a spatial shape and a construction type with a main building material. The proposed solution intends to establish a close relationship between interior and exterior, and optimize the relationship with the sun in order to maximize comfort and passive/active uses of the solar energy. The design is expressed in terms of DPs:

- DP1 = two-story L-type south-oriented space volume
- DP2 = hybrid construction in timber platform frame

Links between FRs and DPs are checked by the design matrix (DM) (Table 1). Strong link is indicated by a large X and weak link by a small x.

Table 1. First level DM.

	DP1	DP2
FR1	X	-
FR2	x	X

Since the construction type is hybrid, there is a weak unwanted link between the defined space and the construction configuration. On the other hand the design would have been strong decoupled if the loading panel construction had been selected in place of the platform frame due to a strong interference between space and construction. Because the aim of the proposal is a robust and flexible building system, the best construction system within the set of timber systems commonly applied by building industry appears the platform frame although it also places design restrictions. In contrast uncoupled designs would be achievable using a timber frame system realized by beams and pillars. In this construction system, the construction function is not affected by the space configuration because the frame system does not separate interior from exterior, and it does not influence the creation of interior spaces. Unfortunately this construction system is not commonly applied by timber building industry.

The top-level FR1 is decomposed into a consistent detailed lower level identifying independent sets of compatible living activities in order to provide adequate spaces for the users' living.

- FR1.1 = accommodate communal living activities
- FR1.2 = accommodate private living activities

- FR1.3 = accommodate accessory activities (parking)
 - FR1.4 = connect activities on different height levels
 - FR1.5 = accommodate outside living activities
- A space configuration is defined according to the specified FRs and existing Cs (Figure 2).

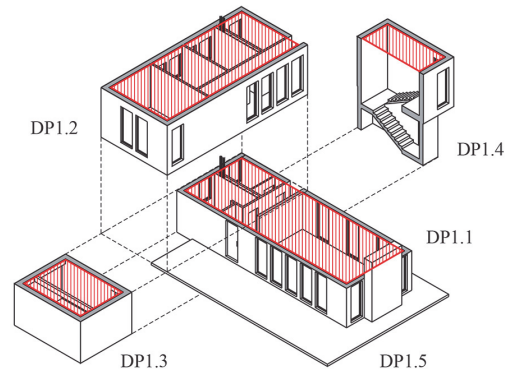

Fig. 2. Space design concept – space modules.

This solution consists of four space modules that implement the identified FRs. Each space module accommodates a set of compatible clients' living activities independently with respect to the others. By mapping, the related DPs are defined below:

- DP1.1 = communal space module (living-dining room, kitchen and services)
- DP1.2 = private space module (bedrooms, bathroom)
- DP1.3 = accessory space module (car parking)
- DP1.4 = accessory space module (staircase)
- DP1.5 = outside living area

Unwanted links are checked in Table 2.

Table 2. Second level DM – FR1.

	DP1.1	DP1.2	DP1.3	DP1.4	DP1.5
FR1.1	X	-	-	-	-
FR1.2	-	X	-	-	-
FR1.3	-	-	X	-	-
FR1.4	-	-	-	X	-
FR1.5	-	-	-	-	X

The resulting DM is diagonal. The artefact architecture is modular. Thanks to the one-to-one mapping between FRs and DPs, each space module provides the expected function without interferences with other functions. In addition thanks to the modular architecture, space modules are freely combinable originating various space configurations (Figure 3) according to different clients' needs, site features and available budget.

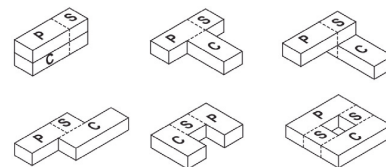

Fig. 3. Communal (C), private (P), service (S) space modules combinations.

They are easily adjustable in terms of function and performance level during the design phase and over during the building lifetime allowing building variations in order to satisfy changed circumstances. In this way, it is also possible to minimize building costs by placing customization effort on modules which are decisive for clients and mass-producing modules which are not crucial for them (such as accessory space modules).

Then also the FR2 is decomposed in a lower level into a minimum set of independent FRs to provide protection, safety, comfort and resources supply:

- FR2.1 = support loads and stabilize
- FR2.2 = separate interior from exterior
- FR2.3 = divide interior spaces
- FR2.4 = connect interior spaces
- FR2.5 = supply and manage resources

The proposed construction solution is shown in Figure 4:

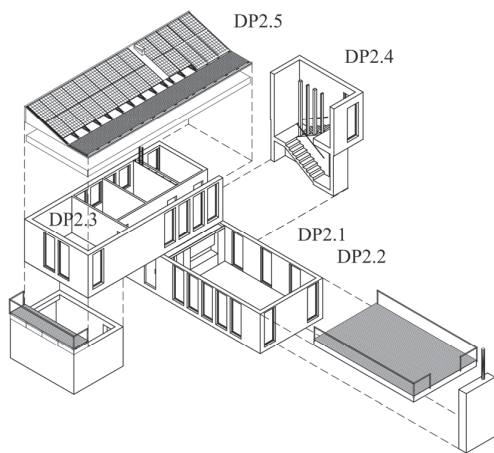

Fig. 4. Construction design concept – construction layers.

It consists of a structural shell that supports and separates inside from outside without interferes with interior partitions and service systems. It is expressed in terms of DPs.

- DP2.1 = squared sections frames with inner sheathing
- DP2.2 = outside sheathing that closes the frame in which the thermal insulation is embedded
- DP2.3 = interior partitions and intermediate floorings
- DP2.4 = staircase
- DP2.5 = photovoltaic-solar panels on the roof and services system core

The design is evaluated by the DM check (Table 3).

Table 3. Second level DM – FR2.

	DP2.1	DP2.2	DP2.3	DP2.4	DP2.5
FR2.1	X	-	-	-	-
FR2.2	X	X	-	-	-
FR2.3	-	-	X	-	-
FR2.4	-	-	-	X	-
FR2.5	-	-	-	-	X

By the DM, it is observed that the solution is decoupled: the independence of the FRs is observed with the exception of the

loadbearing and separating functions. Although in the platform frame system, each individual layer performs essentially just one function, the loadbearing and separating functions are united in the same plane within the wall determining a weak link. Functional independent construction layers allow the fulfilment of the expected performances without compromises with other functions in spite uncertainties (changing customers or functions or physical components). Each DP is combined with the others without compromising function, controllability or introducing unwanted links. Therefore the artefact scheme results in being modular for the most parts. In this way, the design is flexible, and different client's preferences and climate conditions can be easily satisfied. During the building lifetime, construction layers can be easily disassembled, replaced on the basis of their longevity and reassembled subsequently without disrupting the whole. In addition disassembled elements can be dismantled or reused on the basis of material according to sustainable strategies. Considering longevity, construction layers are classified into short, medium and long-term lifetime, and distinguished between permanent and replaceable layers on the basis of factors such as climate and weather, load-carrying capacity, stability and also demand of use. By this classification loadbearing structure and shell have long lifetime (100 years); interior partitions and services system usually have medium lifespan (20 years); equipment and furnishings have short lifetime (5-10 years) [9].

Then FR2.2 is decomposed into a minimum set of independent FRs at the lower level.

- FR2.2.1 = separate inside from outside vertically
 - FR2.2.2 = separate inside from ground
 - FR2.2.3 = separate inside from outside horizontally
- A shell design concept is proposed (Figure 5).

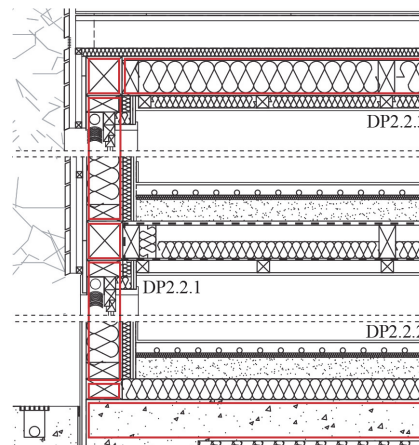

Fig. 5. Shell design concept – shell components.

Platform frame system uses standardized sheathings and identical common timber sections, which are easy and cheap to produce. Since in this system the loadbearing and separating functions do not interfere with the other functions, it is possible to increase the degree of prefabrication by standardized modular panels. Wall, window, flooring and roof pre-made panels are assembled into space modules (Figure 6).

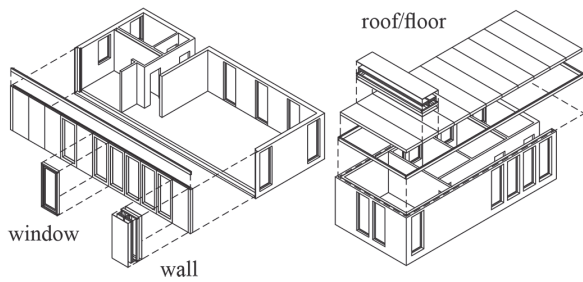

Fig. 6. Shell design concept – prefabricated modular panels.

These panels are produced off-site using the platform frame system and then assembled on site. Modular panels are sized on the basis of the standard board size. These panels are employed to build various space combinations (Figure 7).

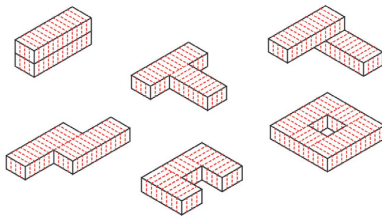

Fig. 7. Building variety using the same modular panels.

The corresponding DPs are defined as follow:

- DP2.2.1 = vertical timber panels, each composed of a frame of squared sections, inner and outer standardized wood-based sheathing and thermal insulation embedded
- DP2.2.2 = insulated reinforced concrete flooring
- DP2.2.3 = horizontal timber panels, each composed of a frame of squared sections, inner and outer sheathings and thermal insulation embedded

The check of the DM is shown in Table 4.

Table 4. Third level DM – FR2.2.

	DP2.2.1	DP2.2.2	DP2.2.3
FR2.2.1	X	-	-
FR2.2.2	-	X	-
FR2.2.3	-	-	X

In the proposed solution, the functional independence of the shell layers allows each performing its function independently and achieving expected performances according to context features or clients' needs. The architecture is modular: the functional independence of shell layers and their independent physical connections allow clients to personalize the shell selecting the favorite components among alternatives. In this way, wall, window, flooring and roof panels can be mass-produced in order to minimize building costs while customization effort is placed only on the parts that are crucial for clients. In addition changes during the building lifetime are easily feasible since panels are able to be installed,

disassembled or reassembled subsequently without interfering with close components and the whole.

The construction system is then specified in detail by the decomposition of the lower level FR2.2.1 and the definition of the corresponding DPs. Facade should provide protection, insulation, support and service supplies accommodation.

- FR2.2.1.1 = protect from external actions
- FR2.2.1.2 = insulate inside from climate variations
- FR2.2.1.3 = resist to external actions
- FR2.2.1.4 = accommodate infrastructure network

Different facade panel types (opaque wall panel, window panel and roof/floor panel) are elaborated in order to satisfy various clients' preferences regarding the facade layout. The proposed opaque wall panel is showed in figure 8.

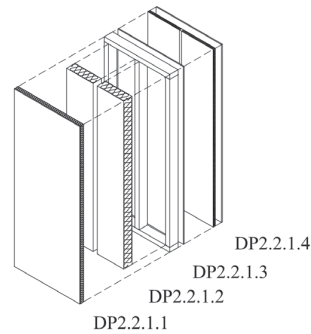

Fig. 8. Facade design concept – opaque wall panel.

The corresponding DPs are defined as follow:

- DP2.2.1.1 = exterior plaster finishing on a compact wood-fiber insulation board
- DP2.2.1.2 = soft wood fiber insulation panels between timber members
- DP2.2.1.3 = squared sections preassembled frame braced by an inner wood-based cladding board
- DP2.2.1.4 = inner retaining plasterboard and interspace filled with service infrastructure network

The check of unwanted couplings is shown in Table 5.

Table 5. Fourth level DM – FR2.2.1.

	DP2.2.1.1	DP2.2.1.2	DP2.2.1.3	DP2.2.1.4
FR2.2.1.1	X	-	-	-
FR2.2.1.2	X	X	-	-
FR2.2.1.3	-	X	X	-
FR2.2.1.4	-	-	-	X

In this system the resisting function strongly interferes with the insulating and protecting functions because of the platform frame. Due to the assigned thickness of the loadbearing frame, the insulating function is not easily adjustable according to context features or clients' needs. Therefore also the protection layer is involved in the insulating function. Instead physical connections between layers are independent. However the identified links between FRs and DPs limits robustness and flexibility of the panels from the architect's viewpoint.

5. Discussion

This application of AD to prefabricated building design firstly shows that the timber construction systems commonly applied by the Italian timber building industry limit artefact robustness and flexibility from the architect's viewpoint. Despite these restrictions, through AD the early decision making has been guided on the development of a building system that is better able to provide the specified requirements. In particular it has observed that these abilities are achievable through the functional independence between space and construction at the upper level and by the functional independence and independent physical connections between construction layers and between spatial modules at the lower levels. At the upper level, space layout slightly affects the construction functionality due to the platform frame. However thanks to its linear members, this building system shows a degree of flexibility with regard to plan layout and openings positioning. At the lower level, this system provides functional independent space modules and independent physical connections. In this way, it results in being robust and flexible regarding the spatial aspect. On the other hand this system is composed of construction layers that are partially functional independent and independently connected due to the platform frame. Therefore it results in being partially robust and flexible with regard to the construction aspect. However the defined building system is better able to foster designs in which customized parts are combined to mass-produced parts thanks to the developed architecture.

6. Conclusions

This research asserts that Italian timber building industry should focus on the adaptive customization of design and production to satisfy the current demand of customized high-performance housing at affordable costs. This strategy needs artefact robustness and flexibility from the designer's viewpoint. Crucial decisions affecting these requirements are made during the conceptual phase, but in this phase suitable design tools are not available. AD has proven being able to support the development of designs with respect to the specified requirements. Therefore this study has applied AD to building design in the housing industry to address decision making towards the development of an adequate prefabricated building system. In spite of limitations placed by current timber construction systems mainly applied in the timber building industry, the defined building system has shown to be enhanced with regard to the specified requirements. Therefore it results in being better able to satisfy the current housing demand since it can foster solutions composed of customized and mass-produced building parts. In this way, customers have the chance to personalize parts that are crucial for them, and building industry can limit costs by the mass production of the others.

Since the pillar-beam frame construction seems to avoid restrictions that are instead placed by the main timber construction systems, a future study intends to investigate its potentialities for the building prefabrication in order to consider its employment into the building industry.

References

- [1] Sabbadin E. La casa nell'epoca del mercato globale dei beni immateriali. In: Ghini A., editor. Casa, tecnologia, ambiente. Sant'Arcangelo di Romagna: Maggioli, 2011; p. 71-81.
- [2] Gardino P. Il mercato italiano delle case in legno: analisi del mercato. c2011 [updates 2013 Mar 15; cited 2015 Apr 11]. Available from http://www.greenews.info/wp-content/Ricerca_Gardino.pdf.
- [3] Pine B. J. Mass customization: the new frontier in business competition. Boston: Harvard Business Review Press; 1992.
- [4] Hatchuel A., Le Masson P., Reich Y., Weil B. A. Systematic approach of design theories using generativeness and robustness. Paper presented at: ICED11. Proceedings of the 18th International Conference on Engineering Design; 2011 Aug 15-18; Copenhagen Denmark. 2011.
- [5] Ulrich, K. T. Design: creation of artefacts in society. Philadelphia: University of Pennsylvania; 2005.
- [6] Marchesi M., Kim S-G., Matt D. Application of the Axiomatic Design approach to the design of architectural systems: a literature review. Paper presented at: ICAD2013. Proceedings of the 7th International Conference on Axiomatic Design; 2013 Jun 26-28; Worcester MA, USA. 2013. p. 154-161.
- [7] Rosenthal, M., Dörrhöfer, A., Staib, G. Components and systems: modular construction. Basel: Birkhäuser; 2008.
- [8] Barrow, L., Al Arayedh, S., Kumar. S. Performance house 1: a CAD/CAM modular house system. Paper presented at: ACADIA 2006. Proceedings of Association for Computer-Aided Design in Architecture 2006 International Conference; 2006 Oct 12-15; Louisville, USA. 2006.
- [9] Deplazes, A. Constructing architecture: materials, processes, structures. Basel: Birkhäuser; 2013. p. 14, 96-98.
- [10] American Institute of Architects, 2007. Integrated project delivery: a guide, AIA, p. 21. c2007 [cited 2015 Apr 11]. Available from http://info.aia.org/SiteObjects/files/IPD_Guide_2007.pdf.
- [11] Roozenburg, N. F. M., Cross N. G. Models of the design process: integrating across the disciplines. Design Studies. 1991; 12(4):215-220.
- [12] Wang, L., Shen, W., Xie, H., Neelamkavil, J., Pardasani, A. Collaborative conceptual design: state of the art and future trends. Computer-Aided Design. 2002;34(13):981-996.
- [13] Thompson, M. K. A classification of procedural errors in the definition of functional requirements in Axiomatic Design theory. Paper presented at: ICAD2013. Proceedings of the 7th International Conference on Axiomatic Design; 2013 Jun 26-28; Worcester MA, USA. 2013. p. 107-112.
- [14] Suh, N. P. The principles of design. New York (NY): Oxford University Press; 1990.
- [15] Suh, N. P. Axiomatic Design: advances and applications. New York (NY): Oxford University Press; 2001.
- [16] Pastor, J. B. R., Benavides E. M. Axiomatic Design of an airport passenger terminal. Paper presented at: ICAD2011. Proceedings of the 6th International Conference on Axiomatic Design; 2011 Mar 30-31; Daejeon, Korea. 2011. p. 95-102.
- [17] Thompson, M. K., Kwon, O. H., Park, M. J. The application of Axiomatic Design theory and conflict techniques for the design of intersections: part 1. Paper presented at: ICAD2009. Proceedings of the 5th International Conference on Axiomatic Design; 2009 Mar 25-27; Lisbon, Portugal. 2009. p. 121-127.
- [18] Thompson, M. K., Park, M. J., Kwon, O. H., Ibragimova, E., Lee, H., Myung, S. The application of Axiomatic Design theory and conflict techniques for the design of intersections: part 2. Paper presented at: ICAD2009. Proceedings of the 5th International Conference on Axiomatic Design; 2009 Mar 25-27; Lisbon, Portugal. 2009. p. 129-136.
- [19] Lindsey R. G. III, Omar M., Farid A. M. An Axiomatic Design based approach for the conceptual design of temporary modular housing. Paper presented at: ICAD2013. Proceedings of the 7th International Conference on Axiomatic Design; 2013 Jun 26-28; Worcester MA, USA. 2013. p. 146-153.
- [20] Marchesi, M., Fernandez, J., Matt, D., Kim, S.-G. Axiomatic Design approach for the conceptual design of sustainable buildings. Paper presented at: ICAD2014. Proceedings of the 8th International Conference on Axiomatic Design; 2014 Sept 26-28; Lisbon, Portugal. 2014. p. 25-33.
- [21] Frampton K. Studies in tectonic culture. Cambridge (MA): MIT Press; 1995. p. 3.